

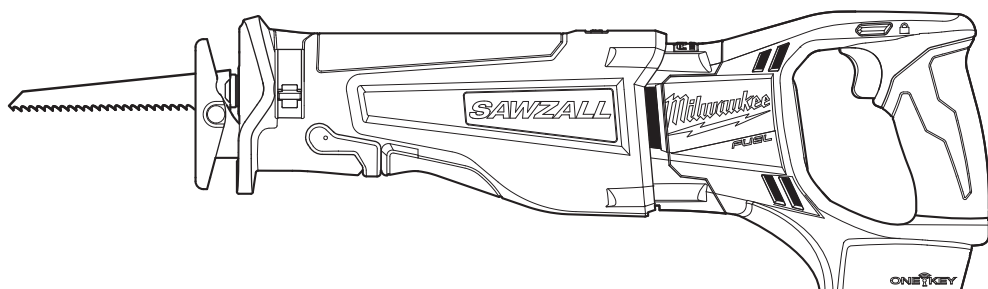

OPERATOR'S MANUAL



Cat. No.
M18ONESX-0

M18™ FUEL™ SAWZALL® RECIPROCATING SAW WITH ONE-KEY™

 **WARNING**

To reduce the risk of injury, user must read and understand operator's manual.



GENERAL POWER TOOL SAFETY WARNINGS

⚠WARNING Read all safety warnings, instructions, illustrations and specifications provided with this power tool. Failure to follow all instructions listed below may result in electric shock, fire and/or serious injury. **Save all warnings and instructions for future reference.** The term "power tool" in the warnings refers to your mains-operated (corded) power tool or battery-operated (cordless) power tool.

WORK AREA SAFETY

- **Keep work area clean and well lit.** Cluttered or dark areas invite accidents.
- **Do not operate power tools in explosive atmospheres, such as in the presence of flammable liquids, gases or dust.** Power tools create sparks which may ignite the dust or fumes.
- **Keep children and bystanders away while operating a power tool.** Distractions can cause you to lose control.

ELECTRICAL SAFETY

- **Power tool plugs must match the outlet. Never modify the plug in any way. Do not use any adapter plugs with earthed (grounded) power tools.** Unmodified plugs and matching outlets will reduce risk of electric shock.
- **Avoid body contact with earthed or grounded surfaces, such as pipes, radiators, ranges and refrigerators.** There is an increased risk of electric shock if your body is earthed or grounded.
- **Do not expose power tools to rain or wet conditions.** Water entering a power tool will increase the risk of electric shock.
- **Do not abuse the cord. Never use the cord for carrying, pulling or unplugging the power tool. Keep cord away from heat, oil, sharp edges or moving parts.** Damaged or entangled cords increase the risk of electric shock.
- **When operating a power tool outdoors, use an extension cord suitable for outdoor use.** Use of a cord suitable for outdoor use reduces the risk of electric shock.
- **If operating a power tool in a damp location is unavoidable, use a ground fault circuit interrupter (GFCI) protected supply.** Use of an GFCI reduces the risk of electric shock.

PERSONAL SAFETY

- **Stay alert, watch what you are doing and use common sense when operating a power tool. Do not use a power tool while you are tired or under the influence of drugs, alcohol or medication.** A moment of inattention while operating power tools may result in serious personal injury.
- **Use personal protective equipment. Always wear eye protection.** Protective equipment such as a dust mask, non-skid safety shoes, hard hat or hearing protection used for appropriate conditions will reduce personal injuries.
- **Prevent unintentional starting. Ensure the switch is in the off-position before connecting to power source and/or battery pack, picking up or carrying the tool.** Carrying power tools with your finger on the switch or energising power tools that have the switch on invites accidents.

- **Remove any adjusting key or wrench before turning the power tool on.** A wrench or a key left attached to a rotating part of the power tool may result in personal injury.
- **Do not overreach. Keep proper footing and balance at all times.** This enables better control of the power tool in unexpected situations.
- **Dress properly. Do not wear loose clothing or jewelry. Keep your hair and clothing away from moving parts.** Loose clothes, jewelry or long hair can be caught in moving parts.
- **If devices are provided for the connection of dust extraction and collection facilities, ensure these are connected and properly used.** Use of dust collection can reduce dust-related hazards.
- **Do not let familiarity gained from frequent use of tools allow you to become complacent and ignore tool safety principles.** A careless action can cause severe injury within a fraction of a second.

POWER TOOL USE AND CARE

- **Do not force the power tool. Use the correct power tool for your application.** The correct power tool will do the job better and safer at the rate for which it was designed.
 - **Do not use the power tool if the switch does not turn it on and off.** Any power tool that cannot be controlled with the switch is dangerous and must be repaired.
 - **Disconnect the plug from the power source and/or remove the battery pack, if detachable, from the power tool before making any adjustments, changing accessories, or storing power tools.** Such preventive safety measures reduce the risk of starting the power tool accidentally.
 - **Store idle power tools out of the reach of children and do not allow persons unfamiliar with the power tool or these instructions to operate the power tool.** Power tools are dangerous in the hands of untrained users.
 - **Maintain power tools and accessories. Check for misalignment or binding of moving parts, breakage of parts and any other condition that may affect the power tool's operation. If damaged, have the power tool repaired before use.** Many accidents are caused by poorly maintained power tools.
 - **Keep cutting tools sharp and clean.** Properly maintained cutting tools with sharp cutting edges are less likely to bind and are easier to control.
 - **Use the power tool, accessories and tool bits etc. in accordance with these instructions, taking into account the working conditions and the work to be performed.** Use of the power tool for operations different from those intended could result in a hazardous situation.
 - **Keep handles and grasping surfaces dry, clean and free from oil and grease.** Slippery handles and grasping surfaces do not allow for safe handling and control of the tool in unexpected situations.
- ### BATTERY TOOL USE AND CARE
- **Recharge only with the charger specified by the manufacturer.** A charger that is suitable for one type of battery pack may create a risk of fire when used with another battery pack.
 - **Use power tools only with specifically designated battery packs.** Use of any other battery packs may create a risk of injury and fire.

•When battery pack is not in use, keep it away from other metal objects, like paper clips, coins, keys, nails, screws or other small metal objects, that can make a connection from one terminal to another. Shorting the battery terminals together may cause burns or a fire.

•Under abusive conditions, liquid may be ejected from the battery; avoid contact. If contact accidentally occurs, flush with water. If liquid contacts eyes, additionally seek medical help. Liquid ejected from the battery may cause irritation or burns.

•Do not use a battery pack or tool that is damaged or modified. Damaged or modified batteries may exhibit unpredictable behavior resulting in fire, explosion or risk of injury.

•Do not expose a battery pack or tool to fire or excessive temperature. Exposure to fire or temperature above 130°C (265°F) may cause explosion.

•Follow all charging instructions and do not charge the battery pack or tool outside the temperature range specified in the instructions. Charging improperly or at temperatures outside the specified range may damage the battery and increase the risk of fire.

SERVICE

•Have your power tool serviced by a qualified repair person using only identical replacement parts. This will ensure that the safety of the power tool is maintained.

•Never service damaged battery packs. Service of battery packs should only be performed by the manufacturer or authorised service providers.

SPECIFIC SAFETY RULES FOR SAWZALL®

•Hold power tool by insulated gripping surfaces, when performing an operation where the cutting accessory may contact hidden wiring. Cutting accessory contacting a "live" wire may make exposed metal parts of the power tool "live" and could give the operator an electric shock.

•Use clamps or another practical way to secure and support the workpiece to a stable platform. Holding the work by hand or against your body leaves it unstable and may lead to loss of control.

•Maintain labels and nameplates. These carry important information. If unreadable or missing, contact a MILWAUKEE® service facility for a replacement.

AWARNING Some dust created by power sanding, sawing, grinding, drilling, and other construction activities contains chemicals known to cause cancer, birth defects or other reproductive harm. Some examples of these chemicals are:

- lead from lead-based paint
- crystalline silica from bricks and cement and other masonry products, and

- arsenic and chromium from chemically-treated lumber.

Your risk from these exposures varies, depending on how often you do this type of work. To reduce your exposure to these chemicals: work in a well ventilated area, and work with approved safety equipment, such as those dust masks that are specially designed to filter out microscopic particles.

SYMBOLOLOGY



Volts



Direct Current

n, XXXX min⁻¹ No Load Strokes per Minute (SPM)

SPECIFICATIONS

Cat. No.	M18ONESX-0
Volts.....	18 DC
No Load Strokes per Minute.....	0 - 3000
Length of Stroke	28.6 mm (1.125")
Battery Type	M18™
Charger Type.....	M18™

FUNCTIONAL DESCRIPTION

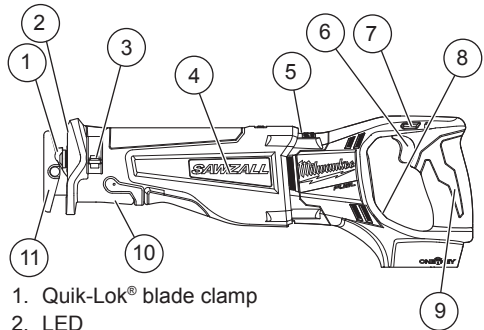

1. Quik-Lok® blade clamp
2. LED
3. Quik-Lok® blade clamp release lever
4. Insulating boot
5. Rafter hook (not shown)
6. Trigger
7. Trigger lock
8. Mode selector
9. Handle
10. Shoe release lever
11. Shoe

ASSEMBLY

WARNING Recharge only with the charger specified for the battery. For specific charging instructions, read the operator's manual supplied with your charger and battery.

Removing/Inserting the Battery

To remove the battery, push in the release buttons and pull the battery pack away from the tool.

WARNING Always remove battery pack before changing or removing accessories.

To insert the battery, slide the pack into the body of the tool. Make sure it latches securely into place.

WARNING Only use accessories specifically recommended for this tool. Others may be hazardous.

Selecting a Blade

The Quik-Lok® Blade Clamp can be used with all 13 mm (1/2") shank universal Sawzall® blades. Use MILWAUKEE® Sawzall® blades for best performance. When selecting a blade, choose the right type and length.

Many types of blades are available for a variety of applications: cutting metal, wood, nail-embedded wood, scroll cutting, roughing-in, and contours. Many lengths are also available. Choose a length long enough to extend beyond the shoe and your work throughout the stroke. **Do not use blades less than 89 mm (3-1/2") long since they won't extend beyond the shoe throughout the stroke.**

Installing and Removing Blades from the Quik-Lok® Blade Clamp

Remove battery pack before changing blades. Make sure the spindle and blade clamp areas are clean. Metal chips and sawdust may prevent the Quik-Lok® Blade Clamp from clamping securely.

1. Depending on the job, the blade may be inserted with the teeth facing up or down. To install a blade, slide the release lever up.

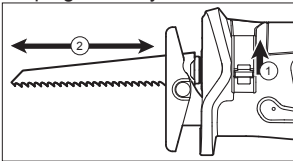

Insert the blade into the clamp until the tang butts against the collar.

2. Release the lever and the spring loaded mechanism will clamp the blade firmly in place.

3. Tug on blade to make sure it is securely locked in place.

4. To remove a blade, slide the release lever up and pull the blade from the tool. Be careful when handling hot blades.

Quik-Lok® Blade Clamp Maintenance

• Periodically clean dust and debris from the Quik-Lok® Blade Clamp with dry compressed air.

• If the collar resists, slide the release lever back and forth to shake debris loose.

• Periodically lubricate Quik-Lok® Blade Clamp with a dry lubricant such as graphite.

Removing broken blades from the Quik-Lok® Blade Clamp

Broken blades can be removed by the following methods.

- Remove battery pack before removing blades.
- Point the tool downward, slide up and hold the release lever, and shake the tool up and down (**DO NOT** turn the tool on while your fingers are holding the blade clamp open). The shank of the broken blade should drop out of the clamp.
- If shaking the tool doesn't work...

In most cases, a corner of the broken blade will extend beyond the blade clamp. Slide up and hold the release lever, and pull the broken blade out of the clamp by this corner.

- If the broken stub doesn't extend far enough to be grabbed by its corner, use a thin blade with small teeth (such as a metal cutting blade) to hook the blade that is jammed in the clamp while holding up the release lever, and pull it out.

WARNING To reduce the risk of injury, be sure the blade always extends beyond the shoe and workpiece throughout the stroke. Blades may shatter if they impact the workpiece or shoe.

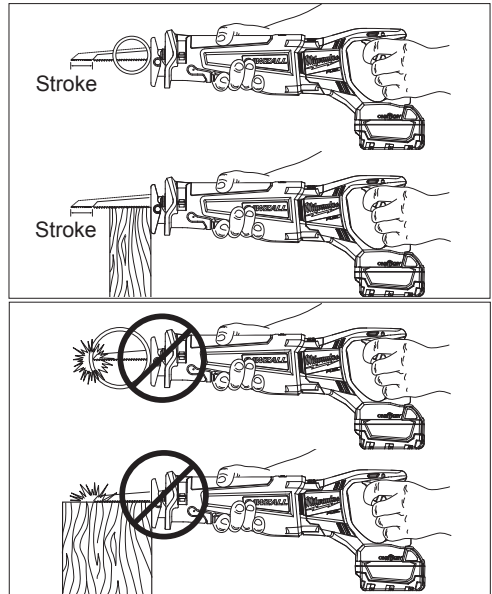

ONE-KEY™

To learn more about the ONE-KEY functionality for this tool, please reference the Quick Start guide included with this product or go to milwaukeeetool.com/One-Key. To download the ONE-KEY app, visit the App Store or Google Play from your smart device.

OPERATION



⚠WARNING Always remove battery pack before changing or removing accessories. Only use accessories specifically recommended for this tool. Others may be hazardous. To reduce the risk of injury, always wear safety goggles or glasses with side shields.

Trigger Lock

To **lock** the trigger, push the trigger lock from the  side of the tool. The trigger will not work while the switch is in the locked position. Always lock the trigger and remove the battery pack before performing maintenance and changing accessories. Lock the trigger when storing the tool and when the tool is not in use.

To **unlock** the trigger, push the trigger lock from the  side of the tool.

Selecting Mode

Allow the tool to come to a complete stop before changing modes. Press the selector button  to cycle between the settings. Select wireless  to change the default settings via the ONE-KEY App on your smart device.

Default Max SPM				
	Setting 1	Setting 2	Setting 3	Setting 4
Max SPM	1500	2400	3000	3000
Ramp-up Time*	1 sec.	2 sec.	3 sec.	N/A

* Ramp-up time is the amount of time it takes for the tool to reach Max Speed. This is beneficial for cutting through dense materials by allowing the blade to bite into the material before increasing in speed, assisting in making a smoother, more accurate cut.

⚠WARNING To reduce the risk of personal injury, always hold tool securely.

Starting, Stopping and Controlling Speed

1. To **start** the tool, grasp the handle firmly and pull the trigger.
2. To **vary** the speed, increase or decrease the pressure on the trigger. The further the trigger is pulled, the greater the speed.
3. To **stop** the tool, release the trigger. Make sure the blade comes to a complete stop before removing the blade from a partial cut or laying the tool down.

Electric Brake

The electric brake engages when the trigger is released, causing the blade to stop and allowing you to proceed with your work. Generally, the saw blade stops within two seconds. However, there may be a delay between the time you release the trigger and when the brake engages. Occasionally the brake may miss completely. If the brake misses frequently, the saw needs servicing by an authorised **MILWAUKEE**® service facility. Always wait for the blade to stop completely before removing the saw from the workpiece.

General Cutting

For straight or contour cutting from an edge, line the blade up with your cutting line. Before the blade contacts the workpiece, grasp the handle firmly and pull the trigger. Then guide the tool along your cutting line. Always hold the shoe flat against the workpiece to avoid excessive vibration.

Cutting Metals

Begin cutting at a slow speed, gradually increasing speed as you cut. When cutting into metals or hard materials that can not be cut from an edge, drill a starting hole larger than the widest part of the blade.

⚠WARNING To reduce the risk of explosion, electric shock and property damage, always check the work area for hidden gas pipes, electrical wires or water pipes when making blind or plunge cuts.

Plunge Cutting

This **MILWAUKEE**® Sawzall® is ideal for plunge cutting directly into surfaces that can not be cut from an edge, such as walls or floors. Plunge cutting may be done two ways depending on how the blade is inserted. Column A shows how to plunge cut with the teeth of the blade facing downward. Column B shows how to plunge cut with the teeth of the blade facing upward. Do not plunge cut into metal surfaces (see "Cutting Metals").

1. Insert the blade into the tool.

If you inserted the blade with the teeth facing downward, hold the tool as shown in Column A, resting the edge of the shoe on the workpiece.

If you inserted the blade with the teeth facing upward, hold the tool as shown in Column B, resting the edge of the shoe on the workpiece.

2. With the blade just above the workpiece, pull the trigger. Using the edge of the shoe as a pivot, lower the blade into the workpiece as shown.
3. As the blade starts cutting, raise the handle of the tool slowly until the shoe rests firmly on the workpiece. Then guide the tool along your cutting line to acquire the desired cut.

NOTE: To make plunge cutting easier, use a heavy gauge blade and install the blade with the teeth facing upward as shown in Column B.

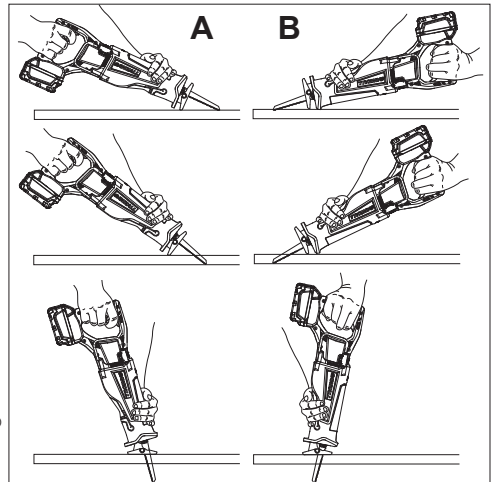

MAINTENANCE

▲WARNING To reduce the risk of injury, always unplug the charger and remove the battery pack from the charger or tool before performing any maintenance. Never disassemble the tool, battery pack or charger. Contact a MILWAUKEE® service facility for ALL repairs.

Maintaining Tool

Keep your tool, battery pack and charger in good repair by adopting a regular maintenance program. Inspect your tool for issues such as undue noise, misalignment or binding of moving parts, breakage of parts, or any other condition that may affect the tool operation. Return the tool, battery pack, and charger to a MILWAUKEE® service facility for repair. After six months to one year, depending on use, return the tool, battery pack and charger to a MILWAUKEE® service facility for inspection.

If the tool does not start or operate at full power with a fully charged battery pack, clean the contacts on the battery pack. If the tool still does not work properly, return the tool, charger and battery pack, to a MILWAUKEE® service facility for repairs.

Internal Battery

An internal battery is used to facilitate full ONE-KEY™ functionality.

To replace the battery:

1. Remove the battery pack.
2. Remove the two screws holding the battery door.
3. Pull out the battery board and remove the old battery.
4. Insert the new battery (3V CR2032), with the positive site away from the board.
5. Slide the board back into the tool and replace the battery door and screws.

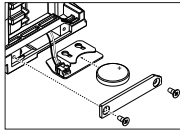

▲WARNING To reduce the risk of personal injury and damage, never immerse your tool, battery pack or charger in liquid or allow a liquid to flow inside them.

Cleaning

Clean dust and debris from vents. Keep handles clean, dry and free of oil or grease. Use only mild soap and a damp cloth to clean, since certain cleaning agents and solvents are harmful to plastics and other insulated parts. Some of these include gasoline, turpentine, lacquer thinner, paint thinner, chlorinated cleaning solvents, ammonia and household detergents containing ammonia. Never use flammable or combustible solvents around tools.

Repairs

For repairs, return the tool, battery pack and charger to the nearest service centre.

ACCESSORIES

▲WARNING Use only recommended accessories. Others may be hazardous.

For a complete listing of accessories, go online to www.milwaukeetools.com.au/ www.milwaukeetools.co.nz or contact a distributor.

WARRANTY - AUSTRALIA and NEW ZEALAND

Please refer to Australian and New Zealand warranty supplied with tool. This warranty applies only to product sold in Australia and New Zealand.

SERVICE - AUSTRALIA and NEW ZEALAND

MILWAUKEE[®] prides itself in producing a premium quality product that is Nothing But Heavy Duty[®]. Your satisfaction with our products is very important to us! If you encounter any problems with the operation of this tool, please contact your authorised *MILWAUKEE*[®] dealer.

For a list of *MILWAUKEE*[®] dealers, guarantee or service agents please contact *MILWAUKEE*[®] Customer Service or visit our website.

(Australia Toll Free Telephone Number 1300 361 505)

(New Zealand Toll Free Telephone Number 0800 279 624)

or visit www.milwaukeetools.com.au / www.milwaukeetools.co.nz.

Milwaukee Electric Tool Corporation

13135 West Lisbon Road, Brookfield, Wisconsin U.S.A. 53005

Milwaukee Electric Tool Corporation (Australia)

Techtronic Industries (Australia) Pty. Ltd.

Rowville, Victoria, Australia, 3178

Milwaukee Electric Tool Corporation (New Zealand)

Techtronic Industries (New Zealand) Pty. Ltd.

Mangere, Auckland, New Zealand, 2022

Professionally made in China for Milwaukee Electric Tool Corporation